

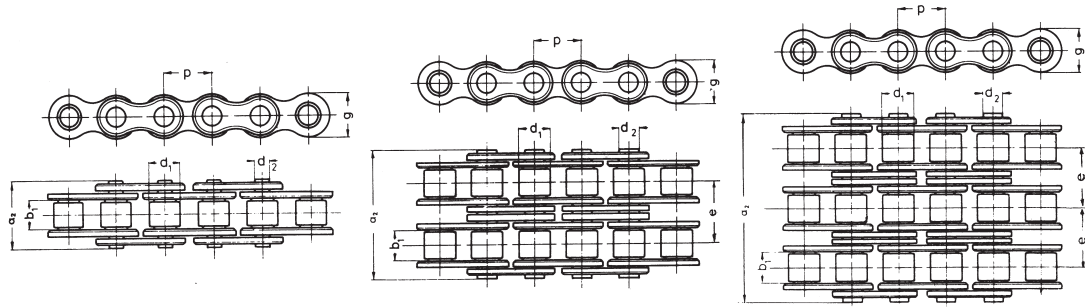

# CATENE A RULLI SERIE EUROPEA TPM®



## SEMPLICE

ISO N.	mm	P	inch	b <sub>1</sub> min. mm	d <sub>2</sub> mm	d <sub>1</sub> max. mm	a <sup>2</sup> max. mm	g max. mm	f cm <sup>2</sup>	kg/m =	caric.. roff.. N. min.
081-1	12.7	1/2"	3.3	3.59	7.75	10.2	9.90	0.20	0.28	7.200	
083-1	12.7	1/2"	4.88	4.09	7.75	12.9	10.30	0.32	0.42	9.200	
084-1	12.7	1/2"	4.88	4.09	7.75	14.8	11.15	0.35	0.59	11.000	

# CATENE A RULLI SERIE EUROPEA QRC®

CATENE PRODOTTE DA AZIENDA CERTIFICATA ISO 9001

## SEMPLICE

ISO N.	mm	P	inch	b <sub>1</sub> min. mm	d <sub>2</sub> mm	d <sub>1</sub> max. mm	a <sup>2</sup> max. mm	g max. mm	f cm <sup>2</sup>	kg/m =	caric.. roff.. N. min.
04-1	6	-	2.80	1.85	4.00	7.4	5.00	0.07	0.12	2.800	
05B-1	8	-	3.00	2.31	5.00	8.6	7.11	0.11	0.18	4.700	
06B-1	9.525	3/8"	5.72	3.28	6.35	13.5	8.26	0.28	0.41	8.200	
08B-1	12.7	1/2"	7.75	4.45	8.51	17.0	11.81	0.50	0.70	16.400	
10B-1	15.875	5/8"	9.65	5.08	10.16	19.6	14.73	0.67	0.95	20.500	
12B-1	19.05	3/4"	11.68	5.72	12.07	22.7	16.13	0.89	1.25	26.500	
16B-1	25.04	1"	17.02	8.28	15.88	36.1	21.08	2.10	2.70	52.500	
20B-1	31.75	1 1/4"	19.56	10.19	19.05	43.2	26.42	2.95	3.60	85.500	
24B-1	38.1	1 1/2"	25.40	14.63	25.40	53.4	33.40	5.54	6.70	153.900	
28B-1	44.45	1 3/4"	30.99	15.90	27.94	65.1	37.08	7.40	8.30	180.000	
32B-1	50.8	2"	30.99	17.81	29.21	67.4	42.29	8.11	10.50	230.000	

## DOPPIA

ISO N.	mm	P	inch	b <sub>1</sub> min. mm	d <sub>2</sub> mm	d <sub>1</sub> max. mm	a <sup>2</sup> max. mm	g max. mm	e mm	f cm <sup>2</sup>	kg/m =	caric.. roff.. N. min.
06B-2	9.525	3/8"	5.72	3.28	6.35	23.8	8.26	10.24	0.55	0.78	15.500	
08B-2	12.7	1/2"	7.75	4.45	8.51	31.0	11.81	13.92	1.00	1.35	28.500	
10B-2	15.875	5/8"	9.65	5.08	10.16	36.2	14.73	16.59	1.34	1.85	41.000	
12B-2	19.05	3/4"	11.68	5.72	12.07	42.2	16.13	19.46	1.78	2.50	53.000	
16B-2	25.4	1"	17.02	8.28	15.88	68.0	21.08	31.88	4.21	5.40	99.500	
20B-2	31.75	1 1/4"	19.56	10.19	19.05	79.7	26.42	35.45	5.91	7.20	162.000	
24B-2	38.1	1 1/2"	25.40	14.63	25.40	101.8	33.40	48.36	11.09	13.50	293.000	
28B-2	44.45	1 3/4"	30.99	15.90	27.94	124.7	37.08	59.56	14.81	16.60	344.000	
32B-2	50.8	2"	30.99	17.81	29.21	126.0	42.29	58.55	16.23	21.00	440.000	

## TRIPLA

ISO N.	mm	P	inch	b <sub>1</sub> min. mm	d <sub>2</sub> mm	d <sub>1</sub> max. mm	a <sup>2</sup> max. mm	g max. mm	e mm	f cm <sup>2</sup>	kg/m =	caric.. roff.. N. min.
06B-3	9.525	3/8"	5.72	3.28	6.35	34.0	8.26	10.24	0.83	1.2	22.800	
08B-3	12.7	1/2"	7.75	4.45	8.51	44.9	11.81	13.92	1.50	2.0	41.000	
10B-3	15.875	5/8"	9.65	5.08	10.16	52.8	14.73	16.59	2.02	2.8	61.500	
12B-3	19.05	3/4"	11.68	5.72	12.07	61.7	16.13	19.46	2.68	3.8	80.000	
16B-3	25.4	1"	17.02	8.28	15.88	99.9	21.08	31.88	6.32	8.0	149.000	
20B-3	31.75	1 1/4"	19.56	10.19	19.05	116.1	26.42	36.45	8.86	11.0	244.000	
24B-3	38.1	1 1/2"	25.40	14.63	25.40	150.2	33.40	48.36	16.64	21.0	438.000	
28B-3	44.45	1 3/4"	30.99	15.90	27.94	184.3	37.08	59.56	22.21	25.0	516.000	
32B-3	50.8	2"	30.99	17.81	29.21	184.5	42.29	58.55	24.34	32.0	671.000	



# CATENE A RULLI SERIE AMERICANA QRC®

CATENE PRODOTTE DA AZIENDA CERTIFICATA ISO 9001

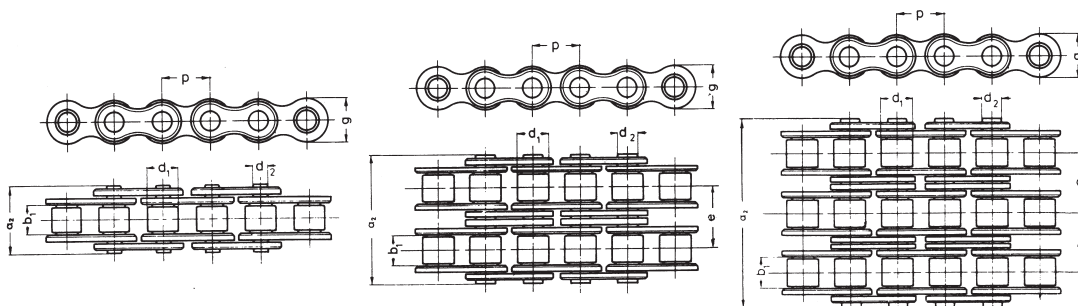

## SEMPLICE "ANSI" ASA

ANSI N.	mm	P	inch	b <sub>1</sub> min. mm	d <sub>2</sub> mm	d <sub>1</sub> max. mm	a <sup>2</sup> max. mm	g max. mm	f cm <sup>2</sup>	kg/m =	caric. roff., N. min.
35-1	9.525	3/8"	4.77	3.58	5.08	13.2	9.05	0.27	0.31	7.350	
40-1	12.7	1/2"	7.95	3.96	7.92	17.8	12.07	0.44	0.61	12.900	
50-1	15.875	5/8"	9.53	5.08	10.16	21.8	15.09	0.70	1.01	20.200	
60-1	19.05	3/4"	12.70	5.94	11.91	26.9	18.08	1.06	1.47	28.900	
80-1	25.4	1"	15.88	7.92	15.88	33.5	24.13	1.79	2.57	51.300	
100-1	31.75	1 1/4"	19.05	9.53	19.05	41.1	30.18	2.62	3.73	80.200	
120-1	38.1	1 1/2"	25.40	11.10	22.23	50.8	36.20	3.94	5.50	115.000	
140-1	44.45	1 3/4"	25.40	12.70	25.40	54.9	42.24	4.72	7.50	156.300	
160-1	50.8	2"	31.75	14.27	28.58	65.5	48.26	6.50	9.70	205.500	

## DOPPIA "ANSI" ASA

ANSI N.	mm	P	inch	b <sub>1</sub> min. mm	d <sub>2</sub> mm	d <sub>1</sub> max. mm	a <sup>2</sup> max. mm	g max. mm	e mm	f cm <sup>2</sup>	kg/m =	caric. roff., N. min.
35-2	9.525	3/8"	4.77	3.58	5.08	21.6	9.05	10.13	0.54	0.67	14.700	
40-2	12.7	1/2"	7.95	3.96	7.92	32.3	12.07	14.38	0.88	1.19	25.600	
50-2	15.875	5/8"	9.53	5.08	10.16	39.9	15.09	18.11	1.40	1.92	40.400	
60-2	19.05	3/4"	12.70	5.94	11.91	49.8	18.08	22.78	2.12	2.90	57.800	
80-2	25.4	1"	15.88	7.92	15.88	62.7	24.13	29.29	3.58	5.01	102.700	
100-2	31.75	1 1/4"	19.05	9.53	19.05	77.0	30.18	35.76	5.24	7.31	160.400	
120-2	38.1	1 1/2"	25.40	11.10	22.23	96.3	36.20	45.44	7.88	10.94	230.000	
140-2	44.45	1 3/4"	25.40	12.70	25.40	103.6	42.24	48.87	9.44	14.36	312.600	
160-2	50.8	2"	31.75	14.27	28.58	124.2	48.26	58.55	13.00	19.10	411.000	

## TRIPLA "ANSI" ASA

ANSI N.	mm	P	inch	b <sub>1</sub> min. mm	d <sub>2</sub> mm	d <sub>1</sub> max. mm	a <sup>2</sup> max. mm	g max. mm	e mm	f cm <sup>2</sup>	kg/m =	caric. roff., N. min.
35-3	9.525	3/8"	4.77	3.58	5.08	31.8	9.05	10.13	0.81	1.01	22.050	
40-3	12.7	1/2"	7.95	3.96	7.92	46.7	12.07	14.38	1.32	1.78	38.300	
50-3	15.875	5/8"	9.53	5.08	10.16	57.9	15.09	18.11	2.10	2.89	60.600	
60-3	19.05	3/4"	12.70	5.94	11.91	72.6	18.08	22.78	3.18	4.28	86.700	
80-3	25.4	1"	15.88	7.92	15.88	91.7	24.13	29.29	5.37	7.47	154.100	
100-3	31.75	1 1/4"	19.05	9.53	19.05	113.0	30.18	35.76	7.86	11.01	240.600	
120-3	38.1	1 1/2"	25.40	11.10	22.23	141.7	36.20	45.44	11.82	16.50	345.000	
140-3	44.45	1 3/4"	25.40	12.70	25.40	152.4	42.24	48.87	14.16	21.70	468.900	
160-3	50.8	2"	31.75	14.27	28.58	182.9	48.26	58.55	19.50	28.30	616.400	

# CATENE A RULLI SERIE AMERICANA RINFORZATA QRC®

## SEMPLICE

ANSI N.	mm	P	inch	b <sub>1</sub> min. mm	d <sub>2</sub> mm	d <sub>1</sub> max. mm	a <sup>2</sup> max. mm	g max. mm	f cm <sup>2</sup>	kg/m =	caric. roff., N. min.
60 H-1	19.05	3/4"	12.70	5.94	11.91	28.9	18.08	1.06	1.70	49.000	
80 H-1	25.4	1"	15.88	7.92	15.88	36.5	24.13	1.79	2.90	84.800	
100 H-1	31.75	1 1/4"	19.05	9.53	19.05	42.9	30.18	2.62	4.40	122.600	
120 H-1	38.1	1 1/2"	25.40	11.11	22.22	54.1	36.19	4.00	6.20	160.500	



# CATENE A RULLI SERIE EUROPEA QRC®

CATENE PRODOTTE DA AZIENDA CERTIFICATA ISO 9001

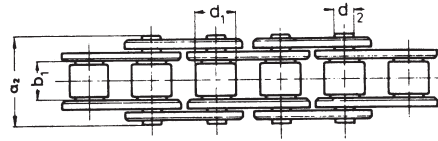
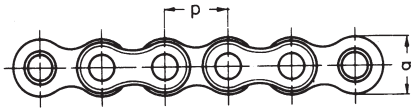

## SEMPLICE ACCIAIO INOX

ISO N.	mm	P	inch	b <sub>1</sub> min. mm	d <sub>2</sub> mm	d <sub>1</sub> max. mm	a <sup>2</sup> max. mm	g max. mm	f cm <sup>2</sup>	kg/m =	caric.. roff.. N. min.
05B-1	8	-	-	3.00	2.31	5.00	8.6	7.11	0.11	0.18	3.400
06B-1	9.525	3/8"	3/8"	5.72	3.28	6.35	13.5	8.26	0.28	0.41	4.400
08B-1	12.7	1/2"	1/2"	7.75	4.45	8.51	17.0	11.81	0.50	0.70	9.800
10B-1	15.875	5/8"	5/8"	9.65	5.08	10.16	19.6	14.73	0.67	0.95	13.600
12B-1	19.05	3/4"	3/4"	11.68	5.72	12.07	22.7	16.13	0.89	1.25	15.000
16B-1	25.4	1"	1"	17.02	8.28	15.88	36.1	21.08	2.10	2.70	39.500

## DOPPIA ACCIAIO INOX

ISO N.	mm	P	inch	b <sub>1</sub> min. mm	d <sub>2</sub> mm	d <sub>1</sub> max. mm	a <sup>2</sup> max. mm	g max. mm	e mm	f cm <sup>2</sup>	kg/m =	caric.. roff.. N. min.
06B-2	9.525	3/8"	3/8"	5.72	3.28	6.35	23.8	8.26	10.24	0.55	0.78	8.400
08B-2	12.7	1/2"	1/2"	7.75	4.45	8.51	31.0	11.81	13.92	1.00	1.35	16.950
10B-2	15.875	5/8"	5/8"	9.65	5.08	10.16	36.2	14.73	16.59	1.34	1.85	27.000
12B-2	19.05	3/4"	3/4"	11.68	5.72	12.07	42.2	16.13	19.46	1.78	2.50	29.700
16B-2	25.4	1"	1"	17.02	8.28	15.88	68.0	21.08	31.88	4.21	5.40	69.000

## NICHELATE

ISO N.	mm	P	inch	b <sub>1</sub> min. mm	d <sub>2</sub> mm	d <sub>1</sub> max. mm	a <sup>2</sup> max. mm	g max. mm	f cm <sup>2</sup>	kg/m =	caric.. roff.. N. min.
06B-1	9.525	3/8"	3/8"	5.72	3.28	6.35	13.5	8.26	0.28	0.41	8.200
08B-1	12.7	1/2"	1/2"	7.75	4.45	8.51	17.0	11.81	0.50	0.70	16.400
10B-1	15.875	5/8"	5/8"	9.65	5.08	10.16	19.6	14.73	0.67	0.95	20.500
12B-1	19.05	3/4"	3/4"	11.68	5.72	12.07	22.7	16.13	0.89	1.25	26.500
16B-1	25.4	1"	1"	17.02	8.28	15.88	36.1	21.08	2.10	2.70	52.500

# CATENE A PIASTRE DIRITTE

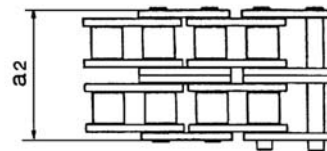
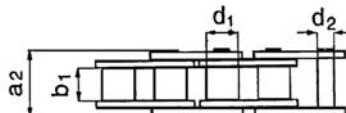
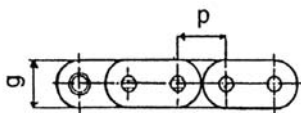

## A PIASTRE DIRITTE

ISO N.	mm	P	inch	b <sub>1</sub> min. mm	d <sub>2</sub> mm	d <sub>1</sub> max. mm	a <sup>2</sup> max. mm	g max. mm	f cm <sup>2</sup>	kg/m =	caric.. roff.. N. min.
08B-1	12.7	1/2"	1/2"	7.75	4.45	8.51	17.0	11.81	0.50	0.80	17.000
10B-1	15.875	5/8"	5/8"	9.65	5.08	10.16	19.6	14.73	0.67	1.00	22.000
12B-1	19.05	3/4"	3/4"	11.68	5.72	12.07	22.7	16.13	0.89	1.30	28.000
16B-1	25.4	1"	1"	17.02	8.28	15.88	36.1	21.08	2.10	2.90	57.000
12B-2	19.05	3/4"	3/4"	11.68	5.72	12.07	42.2	16.13	1.78	2.60	60.000